



EVO 2T

Thanks for your preference, and have a good time! This handbook contains the information you need to properly operate and maintain your motorcycle.

The data, specifications and images shown in this manual does not constitute an engagement on the part of BETAMOTOR S.p.A. BETAMOTOR reserves the right to make any changes and improvements to its models at any moment and without notice.

Code 007440240 000

IMPORTANT

We recommend you to check all the tightenings after the first one or two hours' ride over rough ground. Special attention should be paid to the following parts:

- rear sprocket
- ensure that the footrests are properly fixed
- front/rear brake levers/calipers/discs
- check that the plastics are properly fastened
- engine bolts
- shock absorber bolts/swingarm
- wheel hubs/spokes
- rear frame
- pipe connections
- tensioning the chain

IMPORTANT

In the event of interventions on the vehicle, contact Betamotor after-sales service.

TABLE OF CONTENTS

Operating instructions.....	5
Symbols.....	5
Riding safety	6
CHAPTER 1 GENERAL INFORMATION	7
Vehicle identification data	8
Familiarizing with the vehicle.....	9
Specifications	10
Electrical system.....	14
Recommended lubricants and liquids.....	18
CHAPTER 2 OPERATION	19
Main parts	20
Checks before and after use	24
Breaking in.....	24
Fuelling.....	25
Startup.....	26
Engine shut-down	26
CHAPTER 3 ADJUSTMENTS.....	27
Key to symbols.....	28
Brakes	28
Clutch.....	29
Adjustment of gas clearance.....	29
Accelerator	30
Handlebar adjustment	30
Adjusting fork.....	30
Shock absorber.....	31
Suspension adjustment according to the motorcyclist's weight	32
CHAPTER 4 CHECKS AND MAINTENANCE	33
Key to symbols.....	34
Gear oil.....	34
Coolant	35
Air filter	37
Spark plug	39
Carburetor	40
Front Brake.....	42
Rear brake	44

Clutch control 47
Check of steering gear..... 49
Oil fork..... 50
Tyres..... 54
Chain 55
Headlight..... 57
Rear tail light..... 58
Cleaning the vehicle 59
Prolonged inactivity 60
Scheduled maintenance vehicle 61
Tightening torque overview 62

CHAPTER 5 TROUBLESHOOTING 61
Troubleshooting 62











OPERATING INSTRUCTIONS

- The vehicle must be accompanied by: number-plate, registration document, tax disc and insurance.
- Changes to the engine or other parts is punishable by law with severe penalties, including the confiscation of the vehicle.
- Do not sit on the vehicle stand.
- Do not start the engine in a closed place.

WARNING

Any modifications and tampering with the vehicle during the warranty period exempt the manufacturer from all responsibility and invalidate warranty.

SYMBOLS

-  SAFETY/ATTENTION
Failure to respect information marked with this symbol can entail a personal hazard.
-  INTEGRITY OF THE VEHICLE
Failure to respect information marked with this symbol can entail serious damage to the vehicle and termination of the warranty.
-  FLAMMABLE LIQUID HAZARD
-  Read the use and maintenance manual carefully.
-  MANDATORY TO WEAR PROTECTIVE CLOTHING
Use of the vehicle is subject to wearing specific protective clothing and safety footwear.
-  PROTECTIVE GLOVES MANDATORY
To perform the operations described, it is mandatory to wear protective gloves.
-  FORBIDDEN TO USE NAKED FLAMES OR POSSIBLE UNCONTROLLED IGNITION SOURCES
-  NO SMOKING
-  DO NOT USE MOBILE PHONE
-  CORROSIVE SUBSTANCES HAZARD
Liquids marked with this symbol are highly corrosive: handle with care
-  POISONING HAZARD

RIDING SAFETY

- Observe the Highway Code.
- Always wear approved personal safety equipment.
- Always ride with the low beam on.
- Always keep the crash helmet visor clean.
- Avoid wearing garments with hanging ends.
- Do not keep sharp or brittle objects in your pockets while riding.
- Properly adjust the rearview mirrors.
- Always ride in a seated position, with both hands on the handlebars and both feet on the footrests.
- Never ride abreast with other vehicles.
- Do not tow and avoid being towed by other vehicles.
- Always keep a safe distance from other vehicles.
- Do not start off while the vehicle is on its stand.
- Avoid swaying and wheelies as they are extremely dangerous for your own and other people's safety as well as for your vehicle.
- Always apply both brakes on dry roads with no gravel and sand. Using one brake may be dangerous and cause uncontrolled skidding.
- To reduce the braking distance, always apply both brakes.
- On wet roads and in off-road riding, drive with care and at moderate speed. Take special care in applying the brakes.

CHAPTER 1 GENERAL INFORMATION

CONTENTS

Vehicle identification data	8
Frame identification	8
Engine identification	8
Familiarizing with the vehicle.....	9
Main parts.....	9
Specifications	10
Weight.....	10
Vehicle dimensions	10
Tyres.....	10
Capacities	10
Front suspension.....	11
Rear suspension	11
Front brake.....	11
Rear brake	11
Engine	12
Carburetor.....	12
Gear box	13
Electrical system.....	14
Electrical diagram homologated version	14
Legend electrical diagram homologated version	15
Electrical diagram race version	16
Legend electrical diagram race version	17
Recommended lubricants and liquids.....	18



VEHICLE IDENTIFICATION DATA

FRAME IDENTIFICATION

Frame identification data **A** are stamped on the right side of the steering head tube.

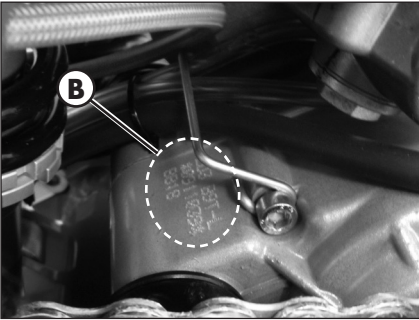

ENGINE IDENTIFICATION

Engine identification data **B** are stamped in the area shown in the picture.

WARNING:

Tampering with the identification numbers is severely punished by law.

FAMILIARIZING WITH THE VEHICLE

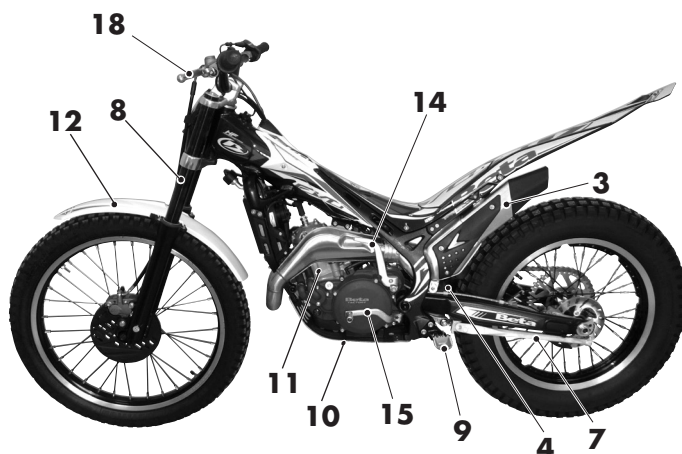

MAIN PARTS

- | | |
|-----------------------|----------------------|
| 1 Fuel tank | 11 Engine |
| 2 Tank cap | 12 Front mudguard |
| 3 Silencer | 13 Rear mudguard |
| 4 Rear shock absorber | 14 Kick-start |
| 5 Headlight | 15 Gear lever |
| 6 Rear light | 16 Rear brake lever |
| 7 Side stand | 17 Front brake lever |
| 8 Fork | 18 Clutch lever |
| 9 Rider's footrests | 19 Throttle |
| 10 Lower bumper | |

SPECIFICATIONS

WEIGHT

Version	EVO 125	EVO 200	EVO 250	EVO 300
Dry weight [kg]	67.5	68.5	68.5	68.5
Front [kg]	33.75	34.25	34.25	34.25
Rear [kg]	33.75	34.25	34.25	34.25

VEHICLE DIMENSIONS

maximum length	1990 mm
maximum width	850 mm
wheelbase	1305 mm
maximum height	1115 mm
ground clearance	310 mm
saddle height	660 mm

TYRES

Dimensions		Pressure [Bar]	
Front tyre	Rear tyre	Front tyre	Rear tyre
2.75 - 21	4.00 - 18	0.4 ÷ 0.5	0.3 ÷ 0.4

CAPACITIES

fuel tank	2.8 litri
including reserve	0.5 litri
coolant circuit:	

Version	EVO 125	EVO 200	EVO 250	EVO 300
With dry circuit [ml]	630	585	530	530
With circuit emptied [ml]	530	485	420	420

gear oil	550 ml
----------------	--------

FRONT SUSPENSION

Version	EVO 125		EVO 200		EVO 250		EVO 300	
Wheel excursion [mm]	166		166		166		166	
	right fork leg	left fork leg	right fork leg	left fork leg	right fork leg	left fork leg	right fork leg	left fork leg
K spring [N/mm]	X	7.65	X	7.65	X	7.65	X	7.65
Oil type	Shell Tellus S2 V32 SAE 6,1							
Oil level [mm] (edge rod with fork compressed)	65	125	65	125	65	125	65	125
Register spring preload	X	full open	X	full open	X	full open	X	full open
Click in extension	full open	X	full open	X	full open	X	full open	X

REAR SUSPENSION

Version	EVO 125	EVO 200	EVO 250	EVO 300
k spring	70N/mm	70N/mm	70N/mm	70N/mm
precharge (spring in its seat) [mm]	126,5	126,5	126,5	126,5
Oil type	oil titan SAF 5045 Eu 137 RED			
Click in extension	3.5 from fully closed	3.5 from fully closed	3.5 from fully closed	3.5 from fully closed

FRONT BRAKE

disk-type with hydraulic control Ø 185 mm

REAR BRAKE

disk-type with hydraulic control Ø 160 mm

ENGINE

Version	EVO 125	EVO 200	EVO 250	EVO 300
Type	Single-cylinder, 2-stroke	Single-cylinder, 2-stroke	Single-cylinder, 2-stroke	Single-cylinder, 2-stroke
Bore x stroke	54 x 54	64 x 60.5	72.5 x 60,5	79 x 60.5
Displacement [cm ³]	123.6	194.6	249.7	296.5
Pressure ratio	14:1	11.8:1	8.9:1	10.17:1
Fuel system	carburetor without mixer (1,5%)	carburetor without mixer (1,5%)	carburetor without mixer (1,5%)	carburetor without mixer (1,5%)

CARBURETOR

Version	EVO 125		EVO 200		EVO 250		EVO 300	
	Certif.	Competition*	Certif.	Competition*	Certif.	Competition*	Certif.	Competition*
Carburetor type	PWK 28		PWK 28		PWK 28		PWK 28	
Main jet	112	130	x	125	42	125	102	125
Slow jet	35	55	x	48	105	48	42	48
Start jet	60	60	x	60	60	60	60	60
Needle	JHL	JJH	x	JJH	LKK	JJH	JHQ	JJH
Needle position (from top)	2°	4°	x	4°	4°	4°	2°	4°
Air screw turns (from all closed)	1 + 1/2	1 + 1/2	x	2 + 1/2	3 + 1/2	2 + 1/2	1/2	2 + 1/2
Spacer	YES	NO	x	NO	YES	NO	YES	NO

* Such modification makes the vehicle non-compliant with the road regulations in force. Its use must be limited to the sole private circuits which are closed to circulation.

Cooling system forced liquid circulation by pump
 Spark plug 125-200 cc NGK BR7ES
 Spark plug 250 cc NGK BPR7ES
 Spark plug 300 cc NGK IR GR7CI-8
 Clutch wet, multidisc

GEAR BOX

Version	EVO 125		EVO 200		EVO 250		EVO 300	
Primary drive	20/71		20/71		22/69		22/69	
Gear ratio 1st gear	12/34		12/34		12/34		12/34	
Gear ratio 2nd gear	14/32		14/32		14/32		14/32	
Gear ratio 3rd gear	15/29		15/29		15/29		15/29	
Gear ratio 4th gear	18/27		18/27		18/27		18/27	
Gear ratio 5th gear	24/22		24/22		24/22		24/22	
Gear ratio 6th gear	28/18		28/18		28/18		28/18	
Secondary drive	Certif.	Competi- tion*	Certif.	Competi- tion*	Certif.	Competi- tion*	Certif.	Competi- tion*
	43/13	43/9	X	42/11	42/13	42/10	42/13	42/10

* Such modification makes the vehicle non-compliant with the road regulations in force. Its use must be limited to the sole private circuits which are closed to circulation.

Ignition 125-200 ccelectronic Hidria 12V-85W
 Ignition 250-300 ccelectronic Hidria 12V-110W

ELECTRICAL SYSTEM

ELECTRICAL DIAGRAM HOMOLOGATED VERSION

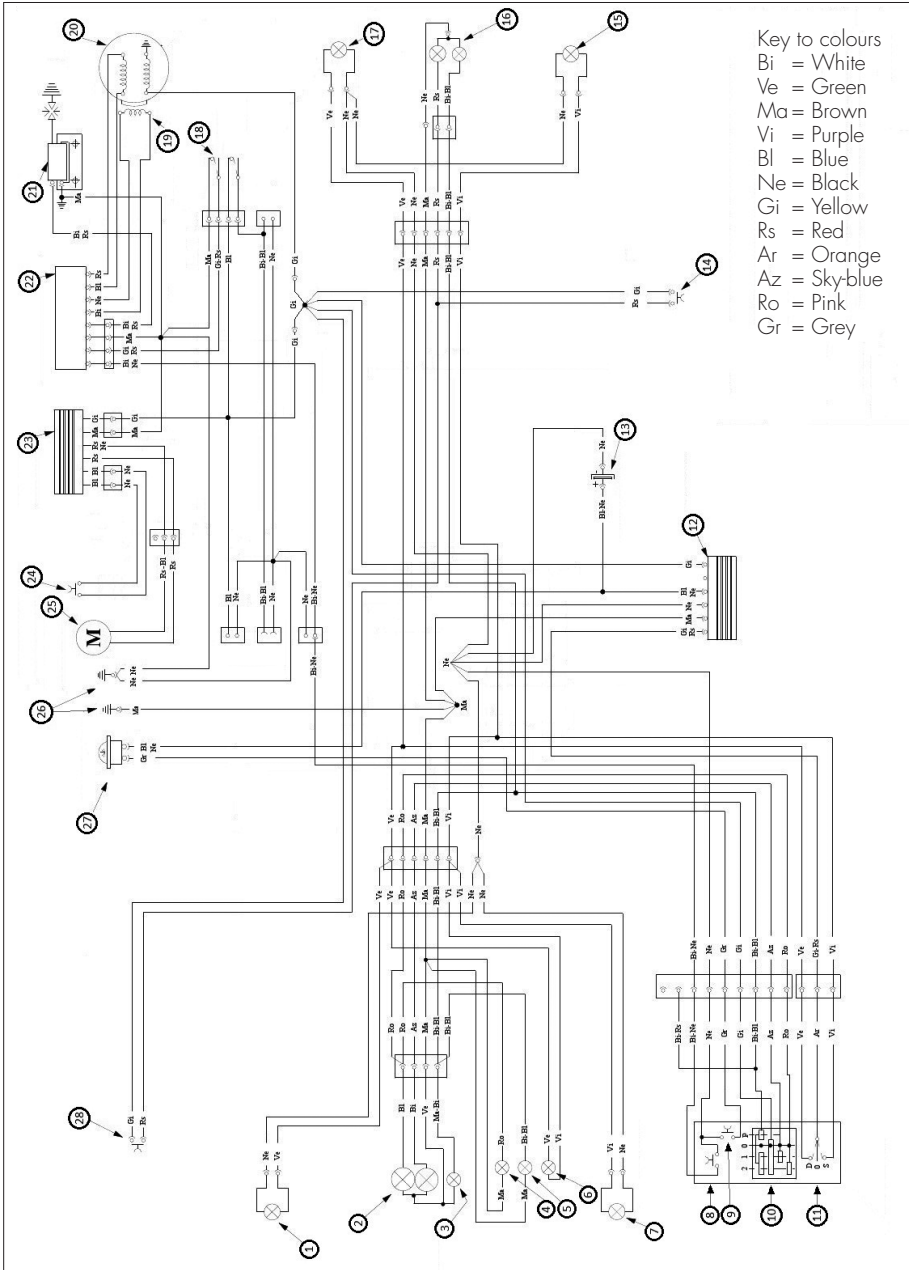

LEGEND ELECTRICAL DIAGRAM HOMOLOGATED VERSION

- 1) R.H. front turn signal with bulb 12V - 10W
- 2) Headlamp (double filament bulb) 12V-35/35W
- 3) Position light with bulb 12V - 5W
- 4) High beam indicator light with bulb 12V 12W
- 5) Dashboard indicator light with bulb 12V 1,3W
- 6) Turn signal indicator light with bulb 12V 1,3W
- 7) L.H. front turn signal with bulb 12V - 10W
- 8) Engine stop button
- 9) Horn button
- 10) Light switch
- 11) Turn signal switch
- 12) Stabilizer
- 13) Condenser 4700 μ F - 25V
- 14) Rear brake stop button
- 15) L.H. rear turn signal with bulb 12V - 10W
- 16) Tail light with bulb 12V - 5/21W
- 17) R.H. rear turn signal with bulb 12V - 10W
- 18) Switch for change mapping
- 19) Pick-up
- 20) Generator
- 21) H.T. coil
- 22) Electronic control unit
- 23) Regulator 12V
- 24) Thermal switch
- 25) Electrofan
- 26) Frame earth
- 27) Horn 12V
- 28) Front brake stop button

ELECTRICAL DIAGRAM RACE VERSION

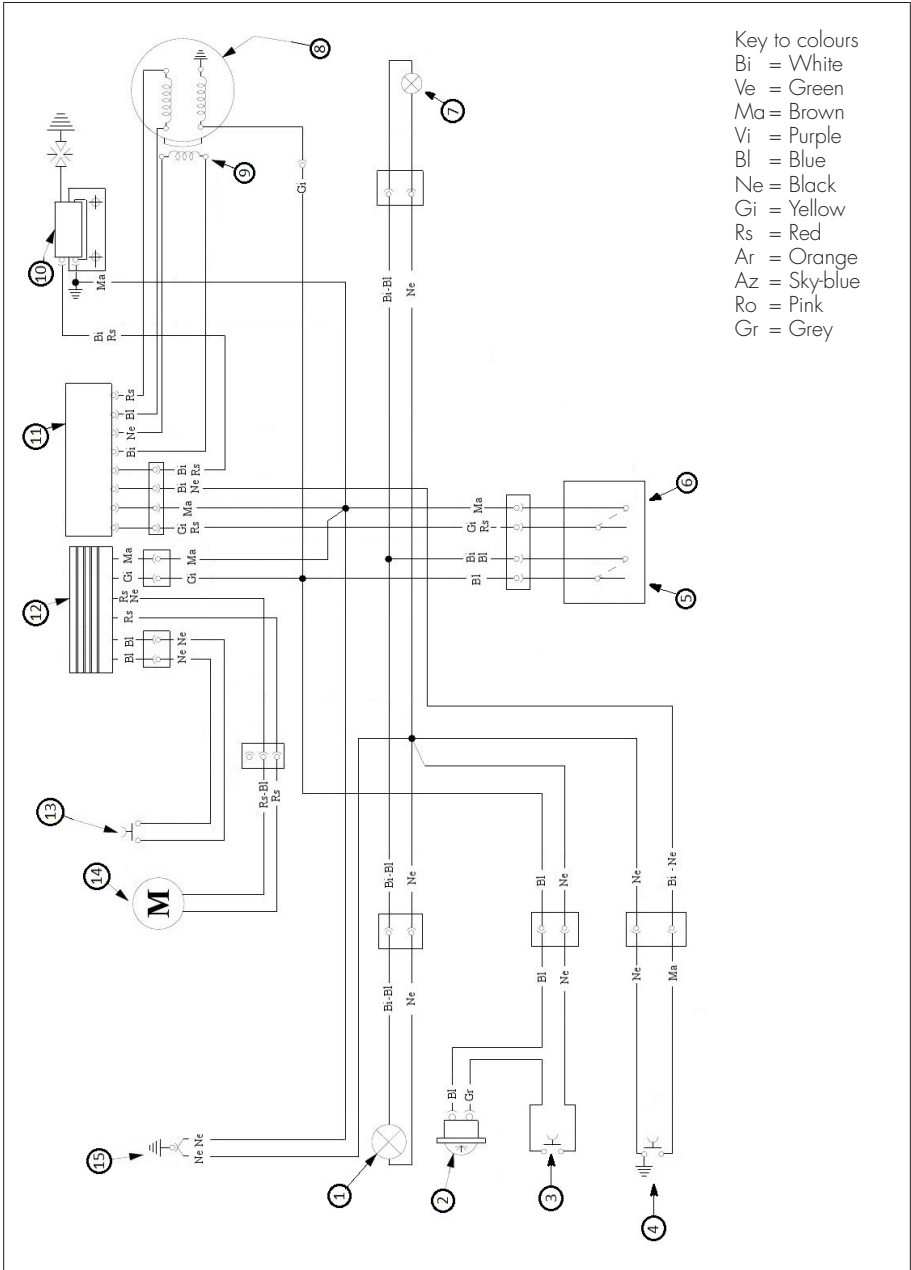

LEGEND ELECTRICAL DIAGRAM RACE VERSION

- 1) Headlamp (double filament bulb) 12V-35/35W
- 2) Horn 12V
- 3) Horn button
- 4) Engine stop button
- 5) Switch for change mapping (yellow)
- 6) Light switch (black)
- 7) Tail light with bulb 12V - 3W
- 8) Generator
- 9) Pick-up
- 10) H.T. coil
- 11) Electronic control unit
- 12) Regulator 12V
- 13) Thermal switch
- 14) Electrofan
- 15) Frame earth

1

RECOMMENDED LUBRICANTS AND LIQUIDS

For better operation and longer vehicle life, we advise you to use the products listed in the following chart:

PRODUCT TYPE	SPECIFICATIONS
OILMIXTURE	LIQUI MOLY RACING SYNTH 2T
GEAR AND CLUTCH OIL	LIQUI MOLY RACING 4T 10W-30
BRAKE OIL	LIQUI MOLY BRAKE FLUID DOT4
CLUTCH ACTUATOR OIL	LIQUI MOLY BRAKE FLUID DOT4
FORK OIL	SHELL TELLUS S2 V32 - SAE 6.1
TIE ROD GREASE	LIQUI MOLY SCHMIERFIXIX
LIQUID COOLANT	LIQUI MOLY COOLANT READY MIX RAF12 PLUS

CHAPTER 2 OPERATION

CONTENTS

Main parts	20
Fuel valve	20
Starter	20
Clutch lever	21
LH switch	21
RH switch	21
Front brake lever and gas control	22
Gearchange lever.....	22
Brake pedal.....	22
Kick-start	22
Checks before and after use	24
Breaking in.....	24
Fuelling.....	25
Startup.....	26
Engine shut-down	26

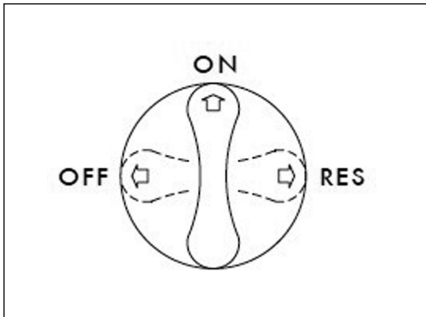
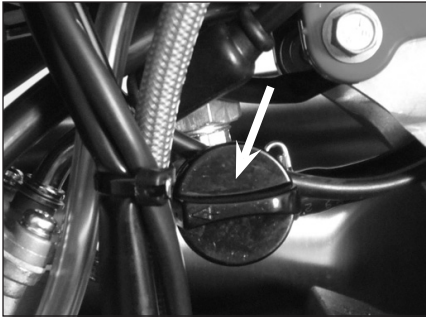

MAIN PARTS

FUEL VALVE

Fuel valve has three positions:

OFF: fuel supply closed. Fuel cannot pass from the tank to the carburettor.

ON: fuel supply enabled. Fuel flows from the tank to the carburettor. The tank empties until it reaches the reserve level.

RES: reserve fuel supply. Fuel flows from the tank to the carburettor and the tank empties completely.

Attention!

During competition use or extreme "trial zone" is advising to position the fuel tap on "RES" to guarantee an optimal fuel supply in all condition use.

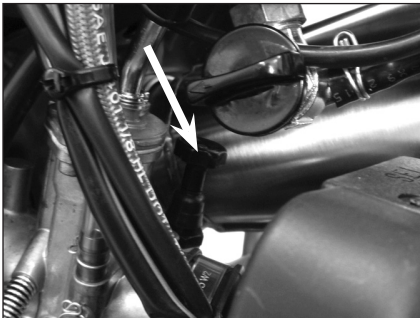

STARTER

The starter lever is located on the carburettor.

To operate the lever pull up.

CLUTCH LEVER

Clutch lever **1** is fitted to the left-hand side of the handlebars. Screw **A** can be used to alter the home position of the lever (see Adjustments).

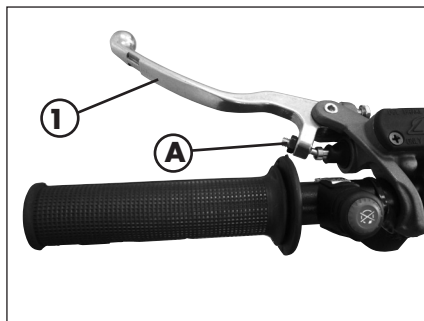

LH SWITCH

The off switch is positioned on the left-hand side of the handlebar and consists of the following:

shut-downs engine : it is necessary to hold it until the engine stops.

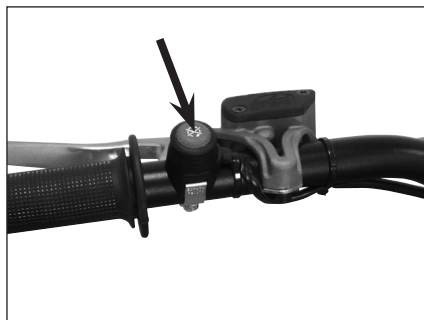



RH SWITCH

The lights and services switch is located on the right-hand side of the radiator and consists of the following:

- 1** Rear light power on/off
- 2** Mapping change switch

By acting on the switch shown in the figure, it is possible to select one of two possible mappings for the ignition advance.

With the switch in position , "soft" mapping more suited to muddy terrain and for a gentler response of the bike is selected. With the switch in position , "hard" mapping that is more suitable for dry land and for a more aggressive response of the bike is selected.

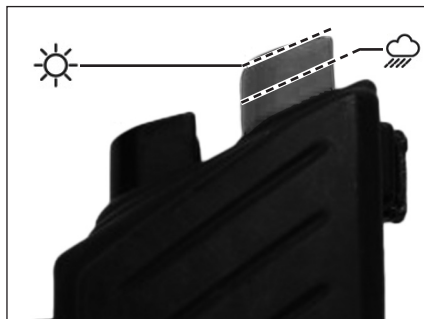
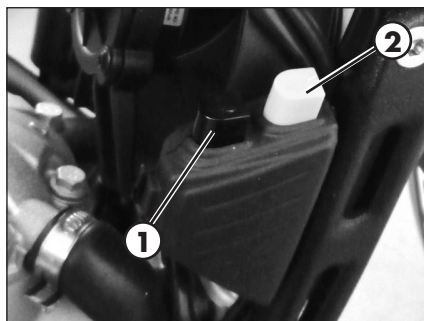

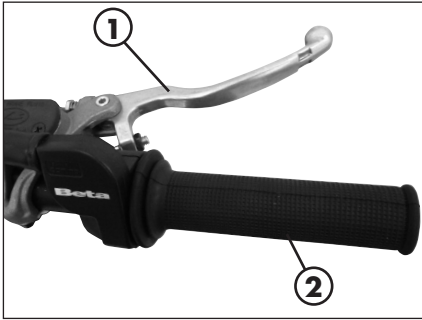

FRONT BRAKE LEVER AND GAS CONTROL

The front brake lever **1** and the gas throttle **2** are located on the right side of the handlebar.

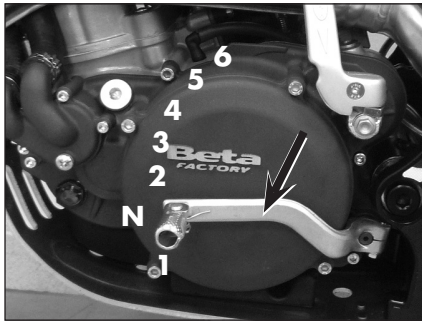

GEARCHANGE LEVER

Gearchange lever is fitted to the left side of the engine.

The positions corresponding to the different gears are shown in the figure.

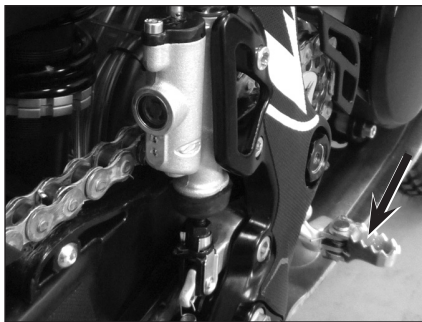

BRAKE PEDAL

Brake pedal is located in front of the right-hand footrest.







KICK-START

The kick-start pedal is located on the left side of the engine. The upper part is rotatable.

SIDE STAND

Press down side stand with the foot and lean the vehicle against it. Ensure that the ground is solid and the vehicle stands steadily.

  **WARNING!** The kickstand has an automatic closing device. When the vehicle weight on the kickstand is reduced, it closes automatically.

  **ATTENTION!** Do not climb on the vehicle with the side stand lowered.

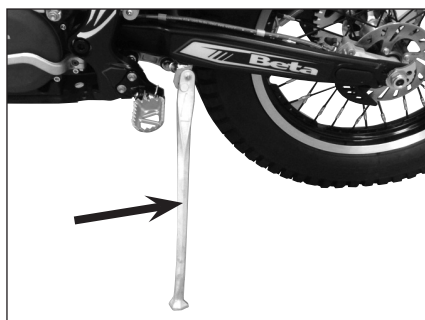

2

CHECKS BEFORE AND AFTER USE

For safe driving and long vehicle life you should:



- Check all fluid levels.



- Check the correct operation of the brakes and brake pad wear (page 44).



- Check pressure, general condition and thickness of tread (page 10).

- Check that the spokes are properly tightened.
- Check the chain tension (page 55).



- Check the adjustment and the operation of all the cable controls.



- Inspect all the nuts and bolts.

- With the engine running, check the operation of the headlight, the rear and brake lights, the indicators, the warning lights and the horn.
- Wash the motorcycle thoroughly after off-road use (page 59).

BREAKING IN

The breaking-in period lasts approximately 5 hours, during which it is advisable to:

- Avoid travelling at constant speed.
- Avoid turning the throttle more than 3/4 of the way.

WARNING:

After the first 5 hours to replace the gearbox oil.

This procedure should be followed each time piston, piston rings, cylinder, crankshaft or crankshaft bearings are replaced.

FUELLING

Use a blend of high-octane unleaded gasoline and synthetic oil at 1,5%.

Fuel tank capacity is shown on page 10.

To open the fuel tank's cap, turn it anti-clockwise.

To close the fuel tank's cap, set it on the tank and crew it clockwise.

For the type of oil mixture refer to the "Recommended fluids and lubricants" table.

 **WARNING:**
The refuelling should be performed with the engine off.

 **WARNING:**
Fire hazard. Fuel is highly flammable.

 Always stop the engine when refuelling and keep open flames and lighted cigarettes away.

 Do not top up fuel while using a mobile phone.

Refuel in an open well ventilated area.

Pay special attention so that the fuel does not come into contact with hot parts of the vehicle. Immediately clean up any spilled fuel.

 **WARNING:** Risk of poisoning.

Fuel is poisonous liquid and a health hazard.

 Fuel must not come into contact with the skin, eyes, and clothing. Do not breathe in the fuel vapours. If contact occurs with the eyes, rinse immediately with plenty of water and seek medical advice. If contact occurs with skin, immediately clean contaminated areas with soap and water. If fuel is swallowed, contact a doctor immediately. Change clothing that is contaminated with fuel.

WARNING: Environmental pollution hazard.

The fuel must not contaminate the ground water, the ground, or the sewage system.



STARTUP

Set the fuel tank tap to ON or RES (see page 20).

- Check that the gears are in neutral (page 22).
- Pull the clutch lever (page 21).

KICKSTART (page 22):

depress the kick-starter with a sharp movement of the foot



ATTENTION

Once the pedal has been depressed, release it immediately. This avoids jolts to the entire ignition group and to the foot.

COLD STARTING:

actuate the starter by pulling it upwards (page 20), start the engine, wait a few seconds, then return the lever to its original position.

ENGINE SHUT-DOWN

To shut-down the engine:

- press the button  on the left switch unit (see page 20).

NOTE:

With the engine stopped, always set the fuel tap to OFF (page 20).

CHAPTER 3 ADJUSTMENTS

CONTENTS

Key to symbols.....	28
Brakes	28
Front brake.....	28
Rear Brake.....	28
Clutch.....	29
Adjustment of gas clearance.....	29
Accelerator	30
Adjusting the idle speed	30
Handlebar adjustment	30
Adjusting fork.....	30
Adjusting the rebound damper	30
Adjusting the spring preload	31
Shock absorber.....	31
Adjusting the rebound damper	31
Adjusting the spring preload	32
Suspension adjustment according to the motorcyclist's weight	32

KEY TO SYMBOLS



Tightening torque



Threadlocker Medium



Grease

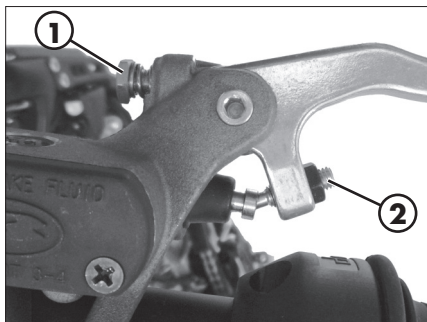

BRAKES

FRONT BRAKE

The front brake is disk type with hydraulic control.

The position of the lever is controlled through the use of register **1**.

Once the position of the lever has been changed, register **2** must be changed to restore the initial correct clearance.

WARNING: reduced play causes brake overheating leading to sudden lockup.

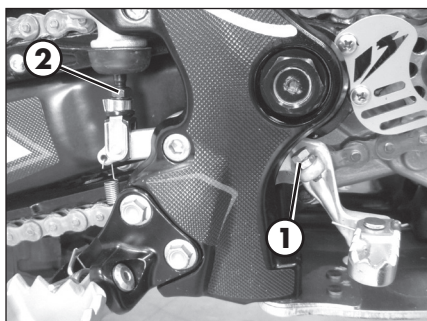

REAR BRAKE

The rear brake is disk type with hydraulic control. You may adjust pedal height by means of register **1**.

Once you change the original pedal position you need to modify regulator **2** on the brake pump to allow you to reset the correct pump travel.

WARNING: reduced play causes brake overheating leading to sudden lockup.

CLUTCH

The position of the lever is controlled through the use of register **1**.

Once the position of the lever has been changed, register **2** must be changed to restore the initial correct clearance.

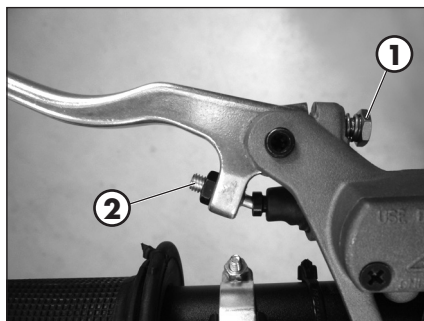

The idle stroke of push rod must not be less than 0.9 mm

 **ATTENTION:** reduced clearance leads to premature wear of the discs and overheating of the entire clutch group.

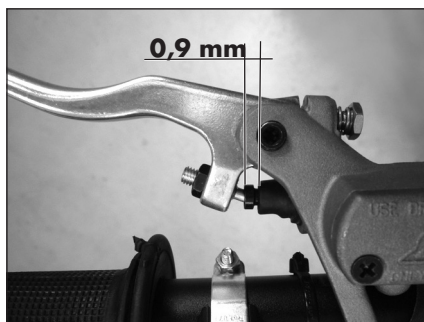

ADJUSTMENT OF GAS CLEARANCE

The throttle control cable should always have a 3-5 mm play. In addition, the idle speed should not change when the handlebars are fully rotated to the left or right.

To adjust the clearance proceed as follows:

- Loosen ring **1**.
- Rotate register **2** with respect to sheath **3**.
- Tighten ring **1**.

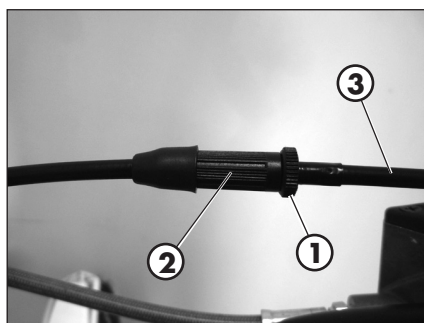

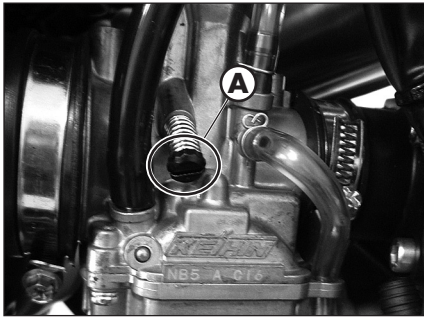

ACCELERATOR

ADJUSTING THE IDLE SPEED

In order to perform this operation correctly, we advise you to do it when the engine is hot, connecting an electric revolution counter to the spark plug wire. Then use a screwdriver on register screw **A** to calibrate the minimum with $900 \div 1000$ rpm.

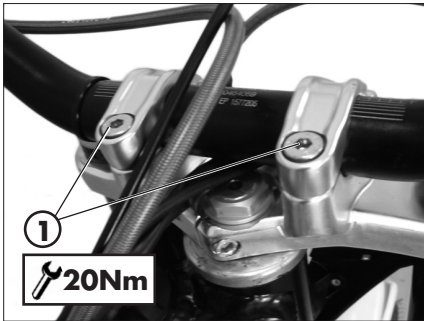

HANDLEBAR ADJUSTMENT

The handlebar can be adjusted by rotating it back and forth.

- To adjust the handlebar loosen screws **1**.
- Position the handlebar according to requirements.
- Tighten to the torque indicated.

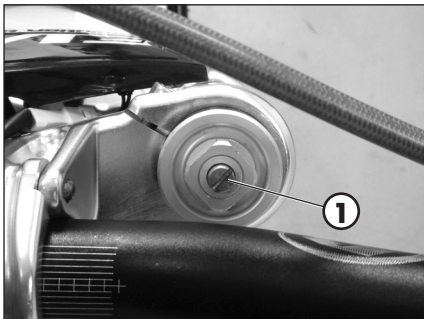

ADJUSTING FORK

ADJUSTING THE REBOUND DAMPER

The hydraulic brake unit in extension determines the behaviour in the extension phase of the fork and can be adjusted using screw **1**. Turning clockwise increases the action of the brake in extension, while rotating counter-clockwise decreases the action of the brake in extension.

For standard calibration, refer to page 11.

ADJUSTING THE SPRING PRELOAD

Spring preload is adjusted by means of screw **2**. Turning clockwise will increase the preload, while rotating counter-clockwise decreases the preload.

For standard calibration, refer to page 11.

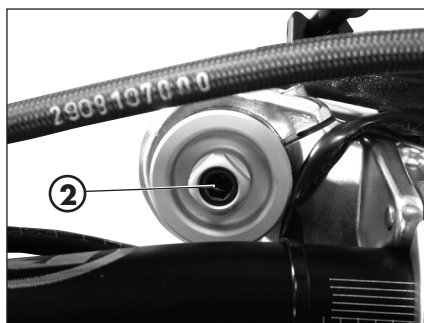

SHOCK ABSORBER

ADJUSTING THE REBOUND DAMPER

The hydraulic brake unit in extension determines the behaviour in the extension phase of the shock absorber and can be adjusted using screw **1**. Turning clockwise increases the action of the brake in extension, while rotating counter-clockwise decreases the action of the brake in extension.

For standard calibration, refer to page 11.

NOTE:

for adjustment use a T-handle wrenches with jointed hexagonal socket.

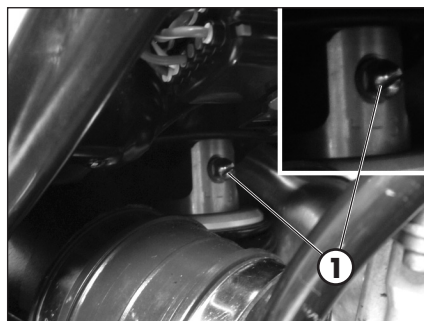

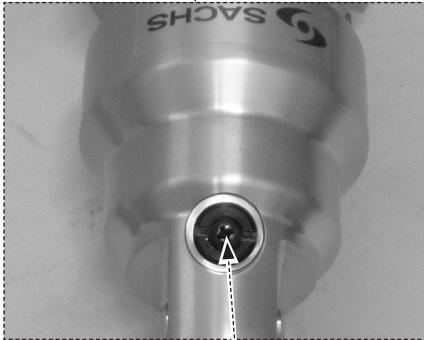
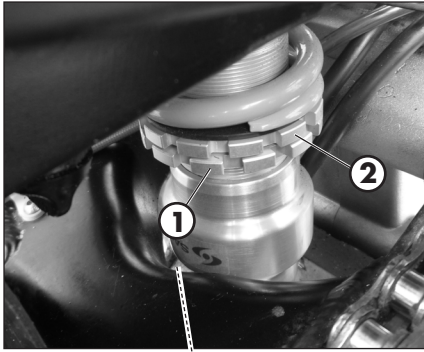

ADJUSTING THE SPRING PRELOAD

To adjust the spring preload, use the procedure described below.

Loosen counter-ring **1**, rotate ring **2** clockwise to increase the spring preload (and consequently the shock absorber preload) or anticlockwise to decrease it.

After obtaining the desired preload, turn counter-ring **1** until it stops against adjusting ring **2**.

For standard calibration, refer to page 11.

NOTE: for movement of the rings use a specific sector key with square pin.

ATTENTION! Do not move the screw **3** under any circumstances.

SUSPENSION ADJUSTMENT ACCORDING TO THE MOTORCYCLIST'S WEIGHT

The following table shows the approximate calibration of the suspension adjustment according to the motorcyclist's weight.

p < 70 Kg		70 Kg < p < 80 Kg		80 Kg < p	
Adjustment		Adjustment		Adjustment	
Fork	Shock absorber	Fork	Shock absorber	Fork	Shock absorber
Standard	Standard	+ 5 turns preload	+ 1,5 turns preload	+ 10 turns preload	+ 3 turns preload

ATTENTION! Shock absorber pre-load max permitted = +6 turns.

CHAPTER 4 CHECKS AND MAINTENANCE

CONTENTS

Key to symbols.....	34
Gear oil.....	34
Check the level.....	34
Replacement.....	34
Coolant.....	35
Check the level.....	35
Replacement.....	36
Radiator grill.....	37
Air filter.....	37
Removing and fitting air filter.....	37
Cleaning air filter.....	38
Spark plug.....	39
Carburetor.....	40
Draining the carburetor float chamber.....	40
Float level check.....	41
Front Brake.....	42
Check the level of the front brake fluid.....	42
Restoring the level of the front brake fluid.....	42
Bleeding the front brake.....	43
Rear brake.....	44
Check the level of the rear brake fluid.....	44
Restoring the level of the rear brake fluid.....	44
Front brake lining control.....	44
Bleeding the rear brake.....	45
Rear brake lining control.....	46
Clutch control.....	47
Check oil level.....	47
Bleeding clutch control.....	48
Check of steering gear.....	49
Oil fork.....	50
Removing legs.....	50
Oil replacement right leg.....	50
Oil replacement left leg.....	51
Legs assembly and parts.....	52
Linkage rear suspension.....	53
Tyres.....	54
Chain.....	55
Check and adjust tightening chain.....	55
Headlight.....	57
Replacing the headlight bulbs.....	57
Rear tail light.....	58
Cleaning the vehicle.....	59
General precautions.....	59
Prolonged inactivity.....	60
Scheduled maintenance vehicle.....	61
Tightening torque overview.....	62

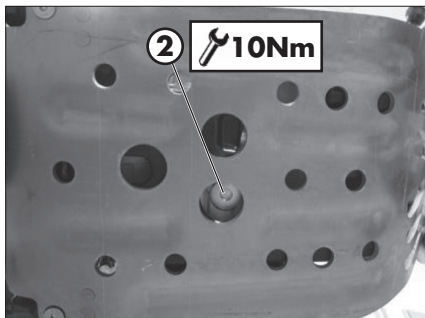
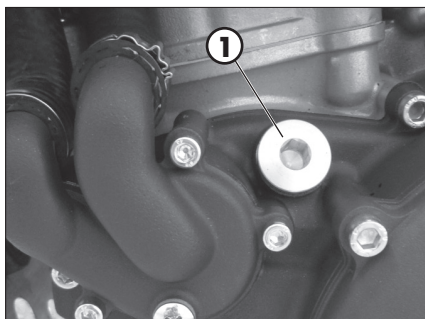
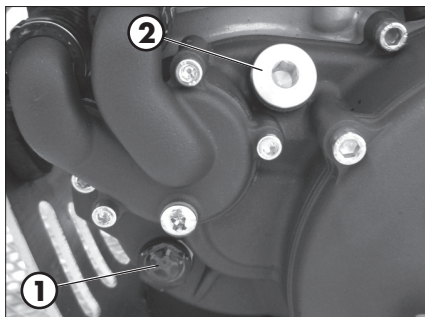

KEY TO SYMBOLS



Tightening torque



Threadlocker Medium



Grease

GEAR OIL

CHECK THE LEVEL

Keep the vehicle in vertical position relative to the ground.

When engine is cold check the oil level by means of porthole **1**. The oil level must be always visible from the porthole.

In contrary case restore the oil level through filler cap **2**.

Use the liquid indicated on page 18 in the "Recommended lubricants and liquids" table.

REPLACEMENT

Always perform the replacement when engine is hot:

- Position the drive on a flat base ensuring stability
- Place a container under the engine
- Unscrew the filler cap **1** and the drain plug **2**
- Completely empty the crankcase
- Close the cap **2**
- Introducing the quantity of liquid shown at page 10.

Use the liquid indicated on page 18 in the "Recommended lubricants and liquids" table.

- Close the filler cap **1**.



WARNING:

Hot oil can cause severe burns!

COOLANT

CHECK THE LEVEL

Keep the vehicle in vertical position relative to the ground.

The level of the coolant must be checked when the engine is cold. Use the following procedure:

- Unscrew cap **1** and ensure that the liquid is visible in the lower portion of the loading tube.
- Where the liquid is not visible in the lower part of the loading tube position the vehicle as in the figure and then top up.
- At the end of operation refit the filler cap and the vent screw.

Use the liquid indicated on page 18 in the "Recommended lubricants and liquids" table.

 **WARNING:** Never unscrew the filler cap of the radiator when the engine is hot. Danger of burning!

 **WARNING:** Wear appropriate protective clothing and protection gloves.

 Keep coolant out of reach of children.

 Avoid any direct contact of the coolant with skin, eyes or clothing. If this happens:

- with the eyes, rinse immediately with plenty of water and seek medical advice;
- with skin, Immediately clean contaminated areas with soap and water Change clothing that is contaminated with coolant.

If coolant is swallowed, contact a doctor immediately.

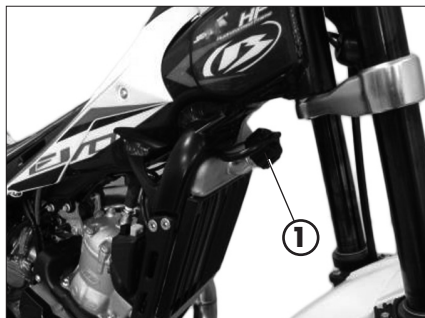

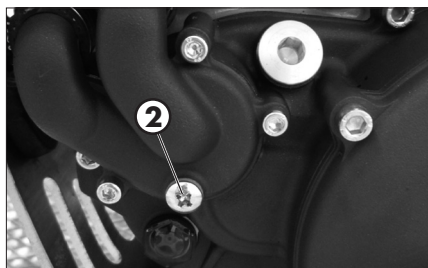
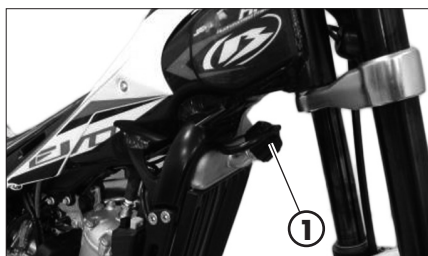

REPLACEMENT

Position the vehicle on a flat base and in a stable manner.

Replacement of the coolant must take place when the engine is cold.

- 1) Unscrew cap **1**.
- 2) Place a container under screw **2**.
- 3) Unscrew the screw **2**.
- 4) Drain the liquid.
- 5) Tighten screw **2** applying the specific washer.
- 6) Unscrew drain screw **3** and fill until the liquid starts to overflow the screw.
- 7) Tighten screw **3**.
- 8) Place the vehicle as shown and proceed to filling.
- 9) Reapply the loading cap **1**.

The amounts of liquid are shown on page 10.

Use the liquid indicated on a page 18 in the "Recommended lubricants and liquids" table.

 **WARNING:**
Never unscrew the filler cap of the radiator when the engine is hot.
Danger of burning!

 **WARNING:**
Wear appropriate protective clothing and protection gloves.

 Keep coolant out of reach of children.

 Avoid any direct contact of the coolant with skin, eyes or clothing. If this happens:

- with the eyes, rinse immediately with plenty of water and seek medical advice;
- with skin, Immediately clean contaminated areas with soap and water Change clothing that is contaminated with coolant.

If coolant is swallowed, contact a doctor immediately.

RADIATOR GRILL

Should the grill be obstructed proceed as follows:

Remove the grill by pulling it towards the front of the vehicle.

Shake and wash the grill.

Reapply the grill pushing it towards the radiator.



AIR FILTER

Check after every ride.

REMOVING AND FITTING AIR FILTER

To access the filter:

- Loosen the fastening screw **1** of the rear cover.

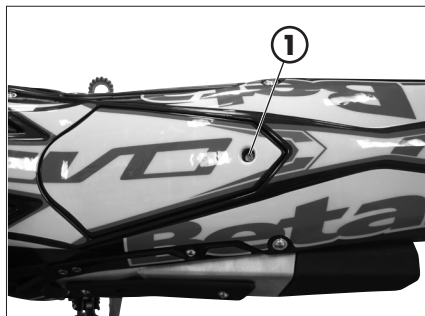



- Remove the filter frame and the filter by unscrewing the screw **2**.

WARNING:
After every intervention, check that nothing has been left inside the filter box.

- Reassemble by performing the operations in reverse order.



CLEANING AIR FILTER

- Thoroughly wash the filter with water and soap.
- Dry the filter.
- Wet the filter with specific oil and then remove the excess oil to prevent it from dripping.
- If necessary also clean the interior of the filter box.

WARNING:
Do not clean the filter with gasoline or petrol.

NOTE:
If the filter is damaged, replace it immediately.

Verify the integrity of water proofing gaskets on air box shown in the picture. Change them if these are damaged.

To replace, contact authorised Betamotor customer service.

 **WARNING:**
Never use the vehicle if the air filter is not in place. The infiltration of dust and dirt can cause damage and considerable wear.

 **WARNING:**
After each operation check that no object is left in the filter box.

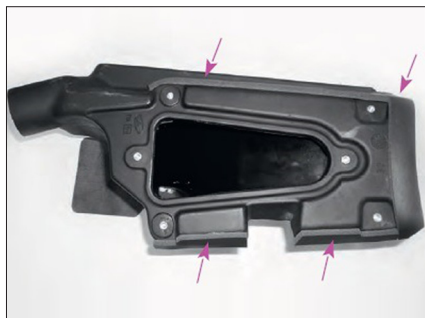

SPARK PLUG

Keeping the spark plug in good condition will reduce fuel consumption and increase engine performance.

To perform the check, simply slide off the electrical connection tube and unscrew the spark plug. Examine the distance between the electrodes with a feeler. This distance should be from 0.7 ± 0.8 mm. If it is not, it may be corrected by bending the earth electrode.

Check as well that there are no cracks in the insulation or corroded electrodes. If so, replace immediately.

When replacing the spark plug, screw it in by hand until it stops, then tighten with a wrench.

 **WARNING:**
Do not check while the engine is hot.

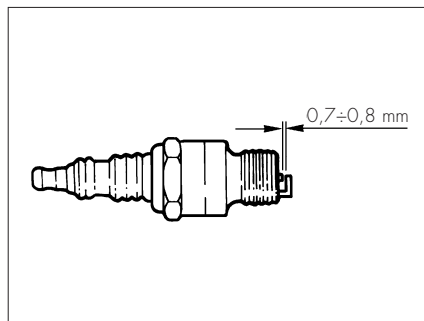



CARBURETOR

DRAINING THE CARBURETOR FLOAT CHAMBER

If the carburetor tank needs to be emptied, proceed as described. Perform the operation once the engine is cold.

Turn the fuel cock to OFF position (see page 20).

Place a cloth under the carburetor in order to collect the fuel that comes out.

Loosen screw **1** and drain the fuel until complete emptying of the tank.

Tighten screw **1**.



WARNING:

Follow action on a cold engine.



WARNING:

Fire hazard. Fuel is highly flammable.



Always stop the engine when refuelling and keep open flames and lighted cigarettes away.

Refuel in an open well ventilated area.



Immediately clean up any spilled fuel.



WARNING:

Risk of poisoning!

Fuel is poisonous liquid and a health hazard.



Wear appropriate protective clothing and protection gloves.

Fuel must not come into contact with the skin, eyes, and clothing. Do not breathe in the fuel vapours. If contact occurs with the eyes, rinse immediately with plenty of water and seek medical advice. If contact occurs with skin, immediately clean contaminated areas with soap and water. If fuel is swallowed, contact a doctor immediately. Change clothing that is contaminated with fuel.

WARNING:

Environmental pollution hazard!

The fuel must not contaminate the ground water, the ground, or the sewage system.

FLOAT LEVEL CHECK

Remove the carburetor from the vehicle after following the procedure for emptying the carburetor bowl.

Remove the bowl and place the carburetor as in the figure.

Start turn it in anticlockwise direction and stop immediately when the float assy closes the fuel valve needle.

The float level is correct if the plan surface over the float assy is parallel to the float chamber division plan. See the two red lines in the picture.

ATTENTION: It's important to avoid putting carburetor in vertical position, otherwise the weight of the float assy compresses the spring into the fuel valve needle and the position will look incorrect.

Replace the bowl to the carburetor.

Reassemble the carburetor to the vehicle, making sure to tighten the metal clamps on the sleeves.

WARNING:

before starting the vehicle to check for play on the throttle (page 29).

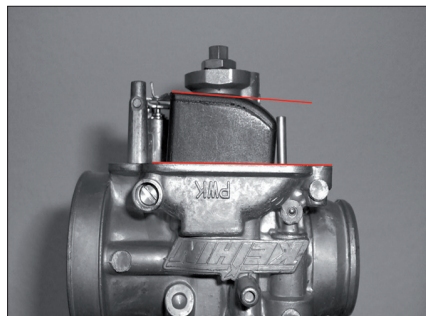
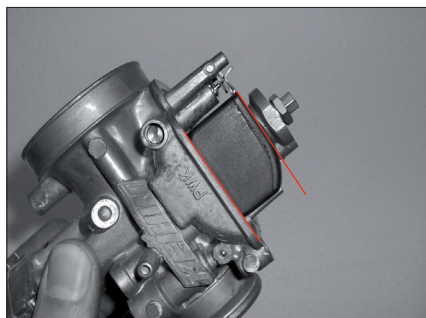

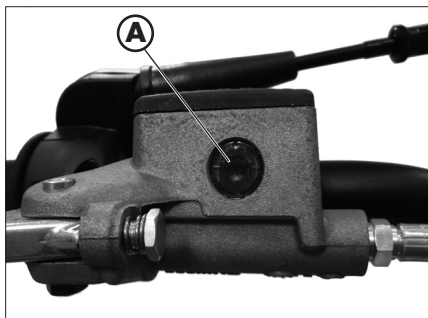

FRONT BRAKE

CHECK THE LEVEL OF THE FRONT BRAKE FLUID

Check the level of the brake fluid through sight **A**. The level of the fluid should never fall below the mark in the sight.

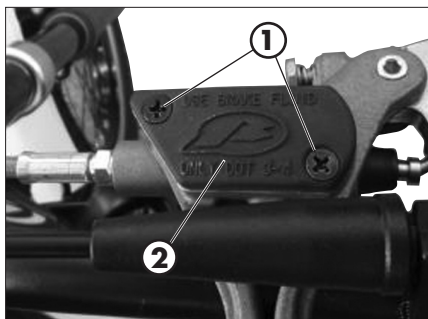

RESTORING THE LEVEL OF THE FRONT BRAKE FLUID

To restore the level of the brake fluid, loosen the two screws **1**, lift cap **2** and add brake fluid until its level is 5 mm below the upper rim of the reservoir.

Use the liquid indicated on page 18 in the "Recommended lubricants and liquids" table.



WARNING:

The clutch fluid is extremely corrosive. Take care not to spill it on the paintwork.



Wear appropriate protective clothing and protection gloves.



Keep coolant out of reach of children.



WARNING: Avoid any direct contact of the liquid with skin, eyes or clothing. If this happens:

- with the eyes, rinse immediately with plenty of water and seek medical advice.
- with skin, immediately clean contaminated areas with soap and water. Change clothing that is contaminated with liquid.

If liquid is swallowed, contact a doctor immediately.

BLEEDING THE FRONT BRAKE

To bleed air from the front brake circuit, proceed as follows:

- Remove the rubber cap **1** from the valve **2**.
- Open the sump cap.
- Insert one end of a transparent tube into a container.
- Pump with the brake lever 2/3 times and keep the lever pressed.
- Unscrew the valve and let the oil drain.
- If air is still visible in the tube repeat above operation until obtaining a continuous outflow of oil without air bubbles.
- Close the valve and release the lever.

NOTE:

During this procedure, continuously top up the brake pump tank to replace the oil that is out flowing.

- Remove the tube.
- Replace the rubber cap.

Close the oil reservoir cap.

Use the liquid indicated on page 18 in the "Recommended lubricants and liquids" table.



WARNING:

The brake fluid is extremely corrosive. Take care not to spill it on the paintwork.



Wear appropriate protective clothing and protection gloves.



Keep coolant out of reach of children.



WARNING: Avoid any direct contact of the liquid with skin, eyes or clothing. If this happens:

- with the eyes, rinse immediately with plenty of water and seek medical advice.
- with skin, immediately clean contaminated areas with soap and water. Change clothing that is contaminated with liquid.

If liquid is swallowed, contact a doctor immediately.



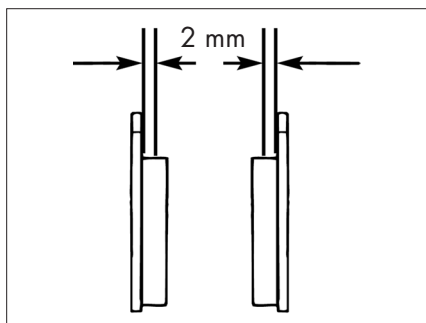

FRONT BRAKE LINING CONTROL

In order to verify the wear condition of front brake is enough to view the caliper from the bottom, where is possible to glimpse the brake lining tails which will have to show a brake of 2 mm in thickness. If the stratum is lesser let's start replacing them.

NOTE:

Perform the check according to the times shown in the table on page 61.

To replace, contact authorised Betamotor customer service.

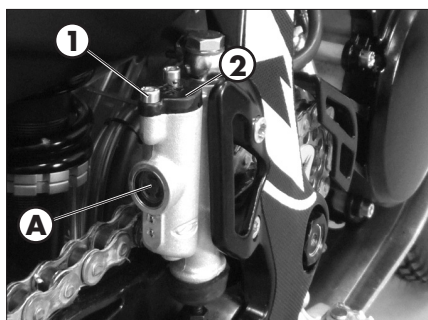

REAR BRAKE

CHECK THE LEVEL OF THE REAR BRAKE FLUID

Check the level of the brake fluid through sight **A**. The level of the fluid should never fall below the mark in the sight.

RESTORING THE LEVEL OF THE REAR BRAKE FLUID

To restore the level of the brake fluid, loosen the two screws **1**, lift cap **2** and add brake fluid until its level is 5 mm below the upper rim of the reservoir.

Use the liquid indicated on page 18 in the "Recommended lubricants and liquids" table.

**WARNING:**

The brake fluid is extremely corrosive. Take care not to spill it on the paintwork.



Wear appropriate protective clothing and protection gloves.



Keep coolant out of reach of children.



WARNING: Avoid any direct contact of the liquid with skin, eyes or clothing. If this happens:

- with the eyes, rinse immediately with plenty of water and seek medical advice.
- with skin, immediately clean contaminated areas with soap and water. Change clothing that is contaminated with liquid.

If liquid is swallowed, contact a doctor immediately.

BLEEDING THE REAR BRAKE

To bleed air from the rear brake circuit, proceed as follows:

- Remove the rubber cap **1** from the valve **2**.
- Open the sump cap.
- Insert one end of a transparent tube into a container.
- Pump with the brake lever 2/3 times and keep the lever pressed.
- Unscrew the valve and let the oil drain.
- If air is still visible in the tube repeat above operation until obtaining a continuous outflow of oil within no air bubbles.
- Close the valve and release the lever.

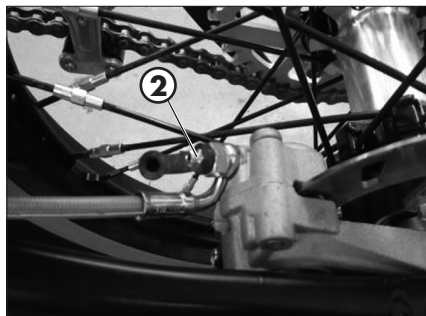
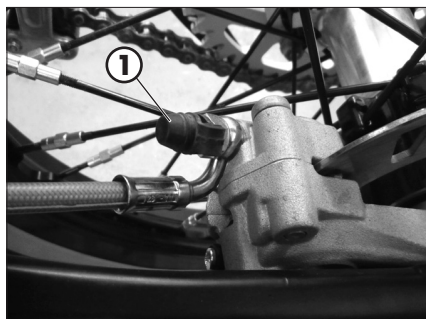

NOTE:

During this procedure, continuously top up the brake pump tank to replace the oil that is out flowing.

- Remove the tube.
- Replace the rubber cap.

Close the oil reservoir cap.

Use the liquid indicated on page 18 in the "Recommended lubricants and liquids" table.

**WARNING:**

The brake fluid is extremely corrosive. Take care not to spill it on the paintwork.



Wear appropriate protective clothing and protection gloves.



Keep coolant out of reach of children.



WARNING: Avoid any direct contact of the liquid with skin, eyes or clothing.
If this happens:

- with the eyes, rinse immediately with plenty of water and seek medical advice.
- with skin, immediately clean contaminated areas with soap and water. Change clothing that is contaminated with liquid.

If liquid is swallowed, contact a doctor immediately.

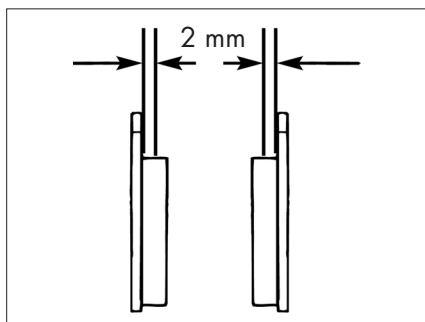
**REAR BRAKE LINING CONTROL**

In order to verify the wear condition of rear brake is enough to view the caliper from the back side, where is possible to glimpse the brake lining tails which will have to show a brake of 2 mm in thickness. If the stratum is lesser let's start replacing them.

NOTE:

Perform the check according to the times shown in the table on page 61.

To replace, contact authorised Betamotor customer service.

CLUTCH CONTROL

CHECK OIL LEVEL

To check the oil level in the clutch pump, first remove cover **1**.

Remove the two screws **2** and take off cover **1** together with the rubber bellows. With the clutch pump in a horizontal position, the level of the oil should be 5 mm below the upper rim.

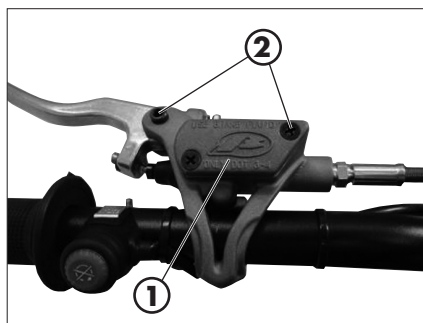

Use the liquid indicated on page 18 in the "Recommended lubricants and liquids" table.



WARNING:

The brake fluid is extremely corrosive. Take care not to spill it on the paintwork.



Wear appropriate protective clothing and protection gloves.



Keep coolant out of reach of children.



WARNING: Avoid any direct contact of the liquid with skin, eyes or clothing. If this happens:

- with the eyes, rinse immediately with plenty of water and seek medical advice.
- with skin, immediately clean contaminated areas with soap and water. Change clothing that is contaminated with liquid.

If liquid is swallowed, contact a doctor immediately.

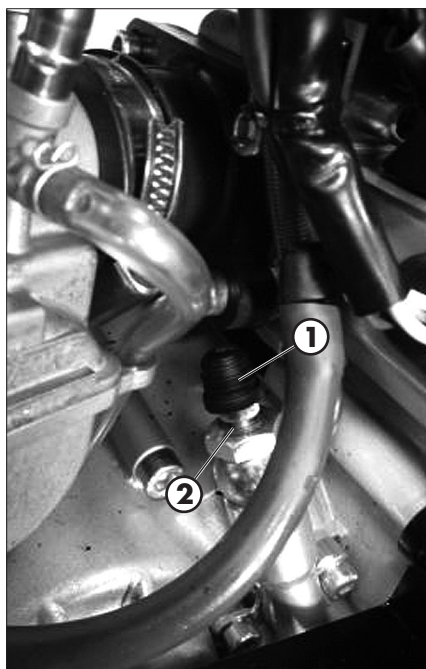

BLEEDING CLUTCH CONTROL

- Remove the rubber cap **1** from the valve **2**.
- Open the sump cap.
- Insert one end of a transparent tube into a container.
- Pump with the brake lever 2/3 times and keep the lever pressed.
- Unscrew the valve and let the oil drain.
- If air is still visible in the tube repeat above operation until obtaining a continuous outflow of oil without air bubbles.
- Close the valve and release the lever.

NOTE:

During this procedure, continuously top up the brake pump tank to replace the oil that is out flowing.

- Remove the tube.
- Replace the rubber cap.

Use the liquid indicated on page 18 in the "Recommended lubricants and liquids" table.



WARNING:

The clutch fluid is extremely corrosive. Take care not to spill it on the paintwork.



Wear appropriate protective clothing and protection gloves.



Keep coolant out of reach of children.



WARNING: Avoid any direct contact of the liquid with skin, eyes or clothing. If this happens:

- with the eyes, rinse immediately with plenty of water and seek medical advice.
- with skin, immediately clean contaminated areas with soap and water. Change clothing that is contaminated with liquid.

If liquid is swallowed, contact a doctor immediately.

CHECK OF STEERING GEAR

Periodically check the play in the steering sleeve by moving the fork back and forth as shown in the figure. Whenever you feel play, adjust as described below:

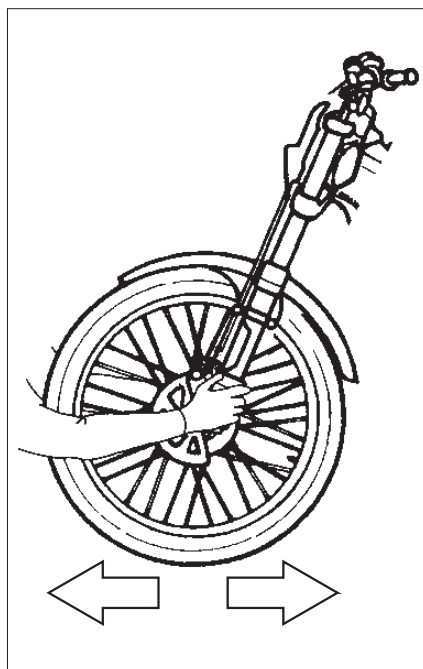

Loosen the screws **1**.

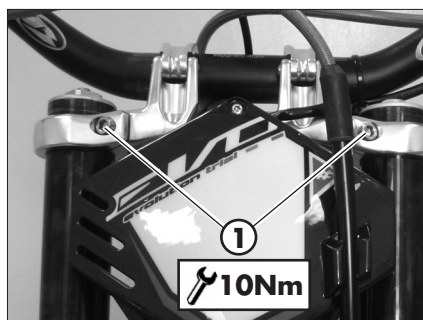

Loosen the screw **2**.

Take up the play by means of nut **3**.

Tighten the screws to the specified torque values.

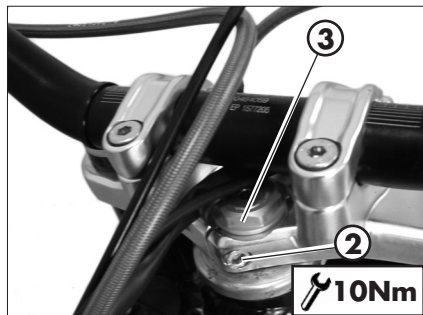

OIL FORK

The procedure for changing the oil in the forks is provided only for information. We recommend having the operation performed by a BETAMOTOR authorized workshop.

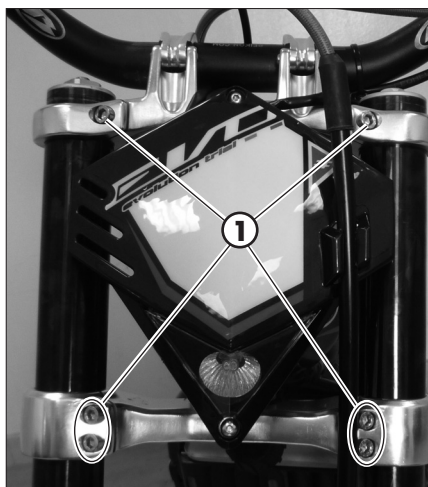

REMOVING LEGS

To replace, proceed as follows:

Position the vehicle on the central bike stand.

Remove the front wheel.

Remove the mudguard, the brake caliper and brake disc cover.

Loosen the screws **1** and pull off the stems.

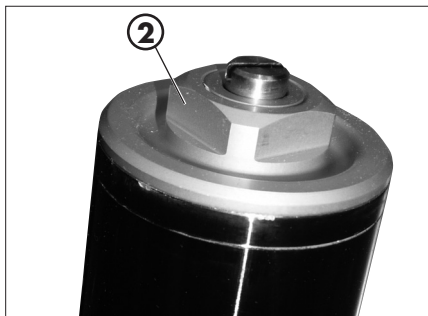

OIL REPLACEMENT RIGHT LEG

Unscrew upper plug **2**.

Unscrew fixing lock nut and take off the plug.

Unscrew the fixing screw of the cartridge positioned under the fork leg, and extract the cartridge.

Empty the fork leg and the cartridge, draining all the oil inside.

Reassemble the cartridge on the fork leg tightening the fixing screw, then refill oil in the cartridge.

Pour in the quantity of liquid indicated on page 11.

Use the liquid indicated on page 18 in the "Recommended lubricants and liquids" table.

Reassemble the plug on the rod, tighten the lock nut and, extending the fork leg.

OIL REPLACEMENT LEFT LEG

Unscrew upper plug **3**.

Remove the spring and totally empty the oil.

Pour in the quantity of liquid indicated on page 11.

Reassemble the spring and extend fork leg.

Apply and tighten cap **3**.



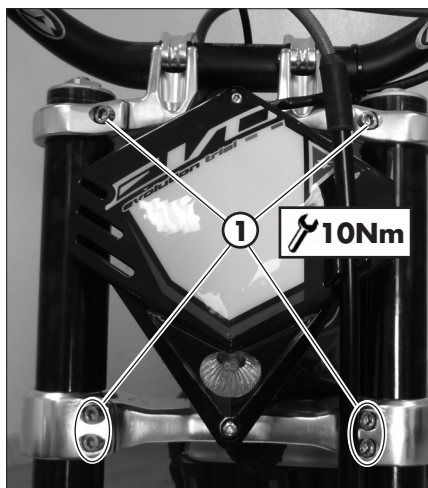

LEGS ASSEMBLY AND PARTS

Apply the legs to the vehicle and tighten the screws **1** to the torque indicated.

ATTENTION: Tightening of the screws should be carried out by adjusting the torque wrench to to the stability torque with repeated tightening until stability torque has been achieved.

Grease the wheel bolt.

Apply wheel and wheel bolt.

Apply brake caliper, disc cover and fender.



Tighten to the torque indicated.

! **ATTENTION:** Tightening of the screws should be carried out by adjusting the torque wrench to to the stability torque with repeated tightening until stability torque has been achieved.

Place the vehicle on the ground.

Compress and release the fork 3-4 times.

Tighten the wheel bolt and the screws of the foot.

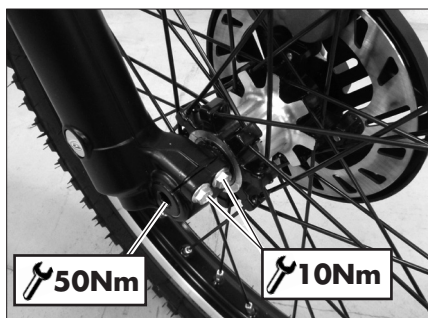

! **ATTENTION:** Tightening of the screws should be carried out by adjusting the torque wrench to to the stability torque with repeated tightening until stability torque has been achieved.

LINKAGE REAR SUSPENSION

To guarantee an optimal operation and the longest lifetime of the progressive linkage of the rear suspension, it is recommended to check after every race/run the correct tightening of the bolt.

Verify that the result of the suspension bolts to specified torque.

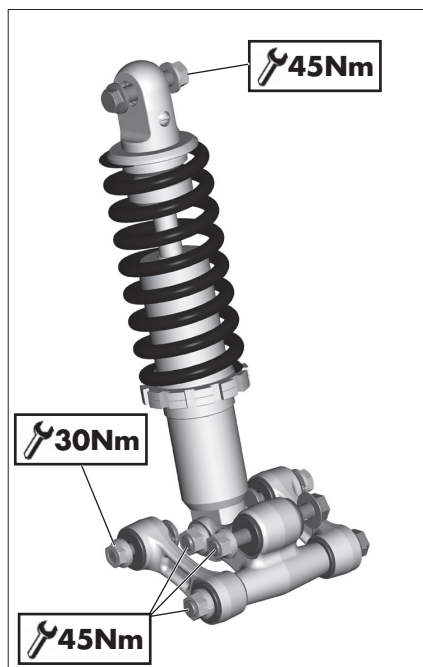

To check the upper shock absorber fastening proceed as follow:

Remove screws **1** and **2** (two per side).
Remove the mudguard.

At the end refit the screws **1** and **2**.

Tighten to the torque indicated.

NOTE: It is recommended not to wash with water jets at high pressure in the zone of the linkage.

Perform the check according to the times indicated in the table on page 61.

To verify device, contact authorised Beta-motor customer service.

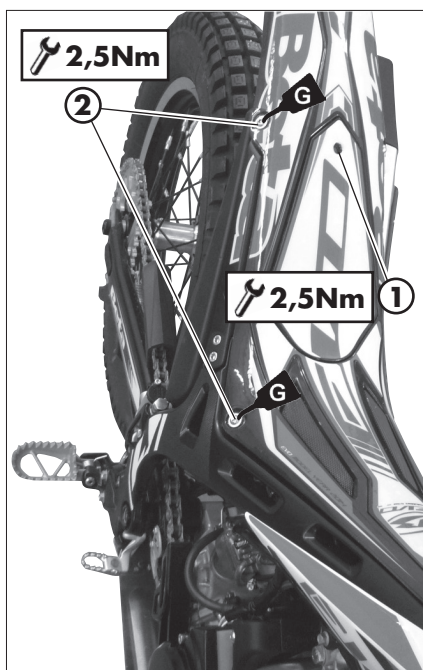

TYRES

Only fit tyres approved by BETAMOTOR. Unsuitable tyres can adversely affect the road holding of the vehicle.

- To protect your safety, immediately replace any damaged tyres.
- Slick tyres adversely affect the road holding of the vehicle, especially on wet roads and in off-road riding.
- Insufficient pressure results in abnormal wear and overheating of the tyres.
- The front and rear tyres must have the same tread design.
- Always measure the inflating pressures when the tyres are cold.
- Keep the tyre pressures within the prescribed range.

CHAIN

Checking the drive chain periodically to ensure longer chain life. Always keep it lubricated and clean of deposited dirt.

Take special care in preventing the lubricant from coming into contact with the rear tyre or brake disc, otherwise the tyre grip and the action of the brake would be greatly reduced, making it very difficult to control the vehicle.

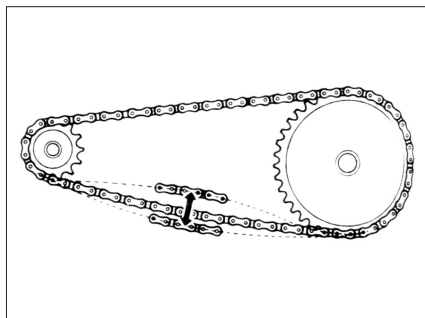

CHECK AND ADJUST TIGHTENING CHAIN

Position the vehicle on the central bike stand.

If the distance between chain and swingarm is less than 20 mm proceed with adjustment.



Loosen the pin **1**.

Rotate register **2** until the distance between chain and swingarm is that recommended.





Rotate register **3** into the same position as register **2**.

Ensure the distance between chain and swingarm is that recommended.

If the distance between chain and swingarm is not that recommended proceed to readjustment.



Tighten the pin to the torque indicated.

HEADLIGHT

Keep the headlight glass clean at all times (page 59).

REPLACING THE HEADLIGHT BULBS

Dismantle the headlight mask removing the two retaining screws **1** indicated in the figure.

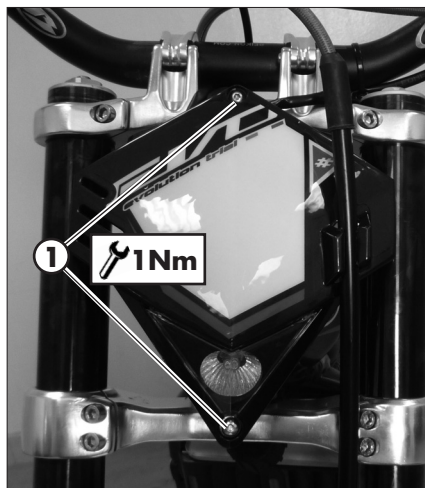

Remove the screws **2** indicated in the figure.

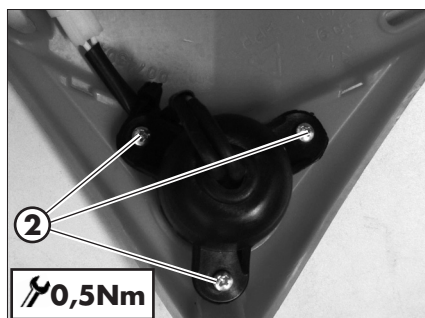

Take out the bulb assembly from the bulb holder.

Remove the bulb from the connectors and carry out replacement.

To reassemble, proceed inversely as described above.





REAR TAIL LIGHT

Keep the tail light glass clean at all times (see page 59).

Remove the screws indicated in the figure.



Remove the bulb holder from its place.

Remove the bulb.

To reassemble, proceed inversely as described above.

CLEANING THE VEHICLE

GENERAL PRECAUTIONS

-  **WARNING:** Do not clean your vehicle with a high-pressure device with a strong jet of water. Excessive pressure can reach electrical components, connectors, flexible cables, bearings, etc and can damage or destroy them.
-  **WARNING:** Wash motorbikes frequently with cold water that are used near the sea (salty air) and on roads subject to salt spreading in winter. Cover with a film of oil or silicone spray unpainted parts and the most exposed parts such as wheels, forks and swingarm. Do not treat rubber parts and brakes.

When cleaning, avoid direct exposure to sunlight.

Close off the exhaust system to prevent water from entering.

-  Avoid directing the jet of water onto the air filter box cover and the carburettor.

WASHING MODE



Use water jet to soften the dirt and mud accumulated on the paintwork, then remove them with a soft bodywork sponge soaked in water and shampoo. Subsequently rinse well with water, and dry with air and cloth or suede leather.

Detergents pollute water. Always wash the vehicle in areas equipped for collection and purification of the washing liquids.

AFTER WASHING

Proceed to the emptying of the filter box using the appropriate ventilation and drying.

After cleaning, ride a short distance until the engine reaches operating temperature.

-   **WARNING:** braking effect is reduced with wet brakes. Operate the brakes cautiously to allow them to dry.

Push back the handlebar control covers, so that water can evaporate.

When the bike is completely dry and cooled down, lubricate all moving parts.

Treat all plastic and painted components with non-aggressive detergents or products that are specific for the care of the motorcycle.

To prevent malfunction of the electrical system, treat electric contacts and switches with electrical contact spray.



ATTENTION: any oxidation of electrical contacts may result in serious malfunctioning.

PROLONGED INACTIVITY

A few simple operations should be performed to keep the vehicle in good condition whenever it is to remain inactive for a long period (e.g. during the winter):

- Thoroughly clean the vehicle.
- Reduce the tyre pressures by approximately 30 percent, and if possible raise the tyres off the ground.
- Remove the spark plug and pour a few drops of engine oil into the spark plug hole. Make the engine turn a few times by operating the kick-start (where available) and then replace the spark plug.
- Cover the unpainted parts, excepting the brakes and the rubber parts, with a film of oil or spray silicone.
- Protect the vehicle with a dust cover.
- Drain the carburetor tank as described at page 40.

AFTER PROLONGED INACTIVITY

- Restore the tyre inflating pressures.
- Check the tightening of all the screws having an important mechanical function.

SCHEDULED MAINTENANCE VEHICLE

Engine	Spark plug	P	End of running: in 5 hours										
			Coupon 1 40 hours or 1.000 Km	Coupon 2 80 hours or 2.000 Km	Coupon 3 120 hours or 3.000 Km	Coupon 4 160 hours or 4.000 Km	Coupon 5 200 hours or 5.000 Km	Coupon 6 240 hours or 6.000 Km	Coupon 7 280 hours or 7.000 Km	Coupon 8 320 hours or 8.000 Km	Coupon 9 360 hours or 9.000 Km		
	Clutch	C	C	C	C	C	C	C	C	C	C	C	C
	Reed valve		C	S	C	C	S	C	C	S	C	S	C
	Cylinder		C	C	C	C	C	C	C	C	C	C	C
	Piston sealing rings		C	S	C	C	S	C	C	S	C	S	C
	Piston			S			S			S		S	
	Water pump fan		C	S	C	S	C	S	C	S	C	S	C
	Shim water pump fan		C	C	C	C	C	C	C	C	C	C	C
	Gear water pump fan		C	C	C	C	C	C	C	C	C	C	C
	Water pump shaft		C	S	C	S	C	S	C	S	C	S	C
	Water pump shaft sealing			S		S		S		S		S	
	Coolant	C	C	S	C	S	C	S	C	C	S	C	C
	Gear oil	S	S	S	S	S	S	S	S	S	S	S	S
	Connecting rod				S			S				S	
	Crankshaft bearings				S			S				S	
	Gear				C			C				C	
Vehicle	Rear shock absorber	C	C	C	C	C	C	C	C	C	C	C	C
	Linkage rear suspension	T	T	C	T	C	T	C	T	C	T	C	T
	Fork oil		S		S		S		S		S		S
	Steering bearings and steering clearance	C	C	C	C	C	C	C	C	C	C	C	C
	Wheel bearings	C	C	C	C	C	C	C	C	C	C	C	C
	Spokes	C	C	C	C	C	C	C	C	C	C	C	C
	Air filter	P	P	S	P	S	P	S	P	S	P	S	P
	Throttle control	C	C	C	C	C	C	C	C	C	C	C	C
	Braking system	C	C	C	C	C	C	C	C	C	C	C	C
	Oil pumps brakes	C	C	C	C	C	C	C	C	C	C	C	C
	Oil clutch actuator	C	C	C	C	C	C	C	C	C	C	C	C
	Transmission chain	C	C	C	C	C	C	C	C	C	C	C	C
	State and tire pressure	C	C	C	C	C	C	C	C	C	C	C	C
	Electrical system	C	C	C	C	C	C	C	C	C	C	C	C

Key

C Check (Clean, adjust, lubricate, replace as necessary)

S Replace/renew

R Adjust

P Clean

T Tighten

4 TIGHTENING TORQUE OVERVIEW

Here below is an overview of the tightening torque of all pieces subject to adjustment or maintenance:

Forecarriage		
	Tightening torque [Nm]	Threadlock
Wheel pin	50	
Fork foots - wheel pin	10*	
Brake caliper - Fork	25	M
Steering head base - fork legs	10*	
Steering head - fork legs	10	
Stem pin on steering head	10	
Upper handlebar u-bolt	20	

Rear axle		
	Tightening torque [Nm]	Threadlock
Wheel pin	80	
Rear shock absorber - frame	45	
Rear shock absorber - rocker arm	45	
Connecting rod - frame	30	
Connecting rod - rocker arm	45	
Rocker arm - swinging arm	45	

Engine		
	Tightening torque [Nm]	Threadlock
Gearbox oil drain plug	10	
Bleeding screw cooling system	10	

Superstructures		
	Tightening torque [Nm]	Grease
Front mudguard	10	
Rear mudguard	2,5	G

Headlamps		
	Tightening torque [Nm]	Threadlock
Headlight mask	1	
Headlight bulb socket	0,5	
Tail light glass	0,5	

M Medium strength threadlock



WARNING:

Tightening of the screws should be carried out by adjusting the torque wrench to the stability torque with repeated tightening until stability torque has been achieved.

CHAPTER 5 TROUBLESHOOTING

CONTENTS

Troubleshooting	66
Alphabetical index	67

5

TROUBLESHOOTING

TROUBLESHOOTING

PROBLEM	CAUSE	REMEDY
The engine turns over but will not start	Fuel valve in OFF position	Move the fuel valve in ON or RES position
	Dirty carburettor jets	Contact authorised Betamotor customer service
	Spark plug dirty	Clean or replace the spark plug
	Spark gap wrongly adjusted	Restore the spark gap (page 39)
	Fault in the ignition system	Contact authorised Betamotor customer service
The power delivered by the engine is insufficient	Tank vent obstructed	Check the tank vent
	Fuel system dirty	Contact authorised Betamotor customer service
	Air filter dirty	Clean the air filter
	Defective ignition system	Contact authorised Betamotor customer service
The motor stops or splutters	Lack of fuel	Move the fuel cock to RES Refuel
	Poor carburettor seal	Make sure that the sleeve between carburetor and engine is intact
	Loose or oxidized connector or ignition coil	Check the connector. Clean and treat with specific spray
Engine overheats (liquid flows out/vapor from the vent radiator)	Radiator grill blocked	Remove and clean the grill (page 37)
	Radiator (air side) blocked	Clean the radiator
	Forced ventilation absent	Check that the cooling fan is working correctly
	Silencer partly clogged	Contact authorised Betamotor customer service
	Carburation too lean	Contact authorised Betamotor customer service
Front braking poor	Brake pads worn	Contact authorised Betamotor customer service
	Air or humidity in the hydraulic circuit	Contact authorised Betamotor customer service
Rear braking poor	Brake pads worn	Contact authorised Betamotor customer service
	Air or humidity in the hydraulic circuit	Contact authorised Betamotor customer service

ALPHABETICAL INDEX

Accelerator	30
Adjusting fork	30
Adjustment of gas clearance.....	29
Air filter	37
Brakes	28
Breaking in.....	24
Carburetor	40
Chain	55
Check of steering gear.....	49
Checks before and after use	24
Cleaning the vehicle.....	59
Clutch.....	29
Clutch control	47
Coolant	35
Electrical system.....	14
Engine shut-down	26
Familiarizing with the vehicle.....	9
Front Brake.....	42
Fuelling.....	25
Gear oil.....	34
Handlebar adjustment	30
Headlight.....	57
Key to symbols.....	28
Key to symbols.....	34
Main parts	20
Oil fork.....	50
Operating instructions.....	5
Prolonged inactivity.....	60

Rear brake 44
 Rear tail light..... 58
 Recommended lubricants and liquids..... 18
 Riding safety 6

Scheduled maintenance vehicle 61
 Shock absorber..... 31
 Spark plug 39
 Specifications 10
 Startup..... 26
 Suspension adjustment according to the motorcyclist’s weight..... 32
 Symbols..... 5

Tightening torque overview 62
 Troubleshooting 66
 Tyres..... 54

Vehicle identification data 8